

AC Contactors

Type IC5181

Specification	MIL-C-2212
Application	Motor control, heater and tungsten lamp switching.
Type	Select standard type (IC5181C) or quiet type (IC5181D) when control is to meet standard MIL-C-740. All quiet contactors undergo special testing at the factory.
Rated Ambient	50° C
Duty	Continuous
Insulation	Class B (coils are Class A)

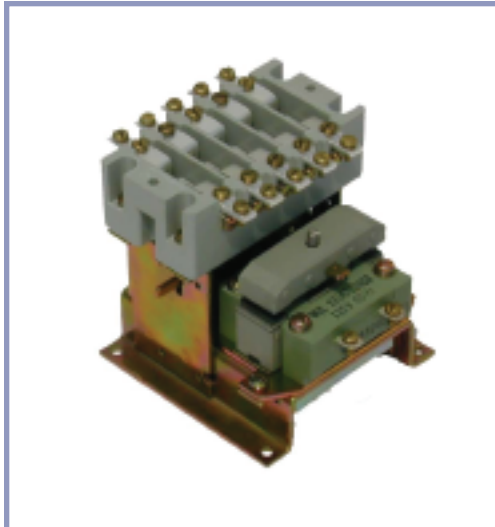

Size 0, 1

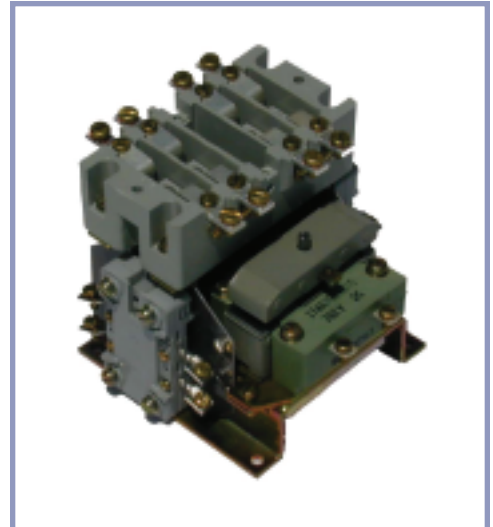

Size 2

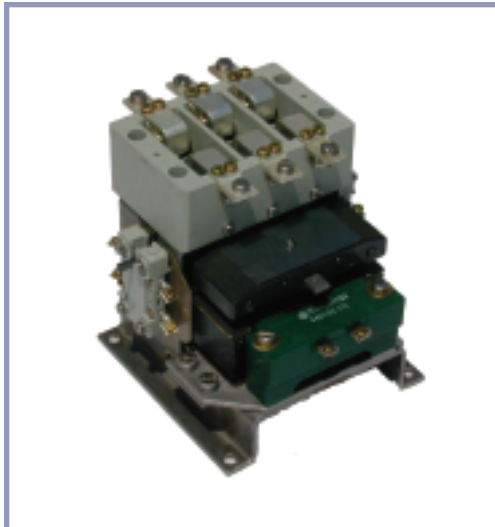

Size 3, 4

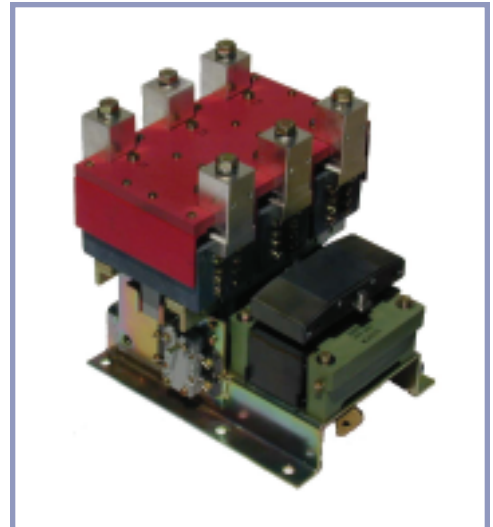

Size 6

AC Contactors

Type IC5181

Size	Poles	Standard			Quiet			
		Basic Catalog Number IC5181		Number of Auxiliary Contacts	Basic Catalog Number IC5181		Number of Auxiliary Contacts	
		115 V Coil 60 Hz	440 V Coil 60 Hz		115 V Coil 60 Hz	440 V Coil 60 Hz		
0	2	C100D3	C100D6	2	D100D3	D100D6	2	
		C100D3	C100D6	4	D100D3	D100D6	4	
	3	C100A3	C100A6	2	D100A3	D100A6	2	
		C100A3	C100A6	4	D100A3	D100A6	4	
	4	C100B3	C100B6	2	D100B3	D100B6	2	
		C100B3	C100B6	4	D100B3	D100B6	4	
	5	C100C3	C100C6	2	D100C3	D100C6	2	
		C100C3	C100C6	4	D100C3	D100C6	4	
1	3	C101A3	C101A6	2	D101A3	D101A6	2	
		C101A3	C101A6	4	D101A3	D101A6	4	
	4	C101B3	C101B6	2	D101B3	D101B6	2	
		C101B3	C101B6	4	D101B3	D101B6	4	
	5	C101C3	C101C6	2	D101C3	D101C6	2	
		C101C3	C101C6	4	D101C3	D101C6	4	
	2	3	C102A3	C102A6	2	D102A3	D102A6	2
			C102A3	C102A6	4	D102A3	D102A6	4
4		C102B3	C102B6	2	D102B3	D102B6	2	
		C102B3	C102B6	4	D102B3	D102B6	4	
5		C102C3	C102C6	2	D102C3	D102C6	2	
		C102C3	C102C6	4	D102C3	D102C6	4	
3		3	C103A3	C103A6	2	D103A3	D103A6	2
			C103A3	C103A6	4	D103A3	D103A6	4
	C103A3		C103A6	6	D103A3	D103A6	6	
	C103A3		C103A6	8	D103A3	D103A6	8	
4	3	C104A3	C104A6	2	D104A3	D104A6	2	
		C104A3	C104A6	4	D104A3	D104A6	4	
		C104A3	C104A6	6	D104A3	D104A6	6	
		C104A3	C104A6	8	D104A3	D104A6	8	
5	3	C105A3	C105A6	2	D105A3	D105A6	2	
		C105A3	C105A6	4	D105A3	D105A6	4	
		C105A3	C105A6	6	D105A3	D105A6	6	
		C105A3	C105A6	8	D105A3	D105A6	8	
6	3	C106A3	C106A6	2	D106A3	D106A6	2	
		C106A3	C106A6	4	D106A3	D106A6	4	
		C106A3	C106A6	6	D106A3	D106A6	6	
		C106A3	C106A6	8	D106A3	D106A6	8	

AC Contactors

Type IC5181

Auxiliary Contact Ratings

Volts	Amperes			
	Carry	Make	Break	
			One Contact	Two Contacts in Series
115 VAC	10	60	10	–
440 VAC	10	60	5	–
115 VDC				
Inductive	10	60	1	2
Noninductive	10	60	5	10
230 VDC				
Inductive	10	60	0.5	1
Noninductive	10	60	2	4

Control Power Requirements

Size	Amperes Holding		Amperes Inrush	
	115 V	440 V	115 V	440 V
0, 1	0.33	0.08	2.1	0.5
2	.63	.15	5.0	1.2
3, 4	.75	.18	10.9	2.6
5, 6	1.2	.40	32.0	10.0

Note: Pick-up voltage is approximately 74-79% of rated coil voltage.
 Drop-out voltage is approximately 40-45% of rated coil voltage.

Note: Auxiliary contacts can be changed from N.O. to N.C. and vice versa without addition of parts.

Application

Size	Motor Horsepower Non-plugging and Nonjogging Duty			Encl. Rating Amp Cont	Tungsten Lamp Load Amp	Make Amp	Break Amp
	Single Phase	Three Phase					
	115 V	115 V	440 V				
0	1	2	5	18	10	108	108
1	2	3	10	27	15	162	162
2	3	7.5	25	45	30	270	270
3	7.5	15	50	90	60	540	540
4	–	25	100	135	120	810	810
5	–	–	200	270	180	1620	1620
6	–	–	400	540	–	3240	3240

Note: Enclosed rating shown is 90% of open rating.

Auxiliary Contact Arrangements

No. of Auxiliary Contacts	Arrangements		Catalog No. Indicator
	Size 0 – 1 – 2 Contactors		
	N.O.	N.C.	
0	0	0	XX
2	2	0	BX
	1	1	AX
4	0	2	CX
	0	4*	CC
4	1	3*	AC
	2	2	AA
	3	1	AB
	4	0	BB

No. of Auxiliary Contacts	Arrangements		Catalog No. Indicator
	Size 3 – 4 – 5 – 6 Contactors		
	N.O.	N.C.	
0	0	0	XX
2	2	0	XBXX
	1	1	XAXX
	0	2	XCXX
4	0	4	XCCX
	1	3	XACX
	2	2	XAAX
	3	1	XABX
	4	0	XBBX
6	6	0	BBBX
	5	1	ABBX
	4	2	ABAX
	3	3	AAAX
	2	4	ACAX
	1	5	ACCX
	0	6	CCCX
8	8	0	BBBB
	7	1	ABBB
	6	2	ABBA
	5	3	AABA
	4	4	AAAA
	3	5	AACA
	2	6	ACCA
	1	7	ACCC
0	8	CCCC	

*This auxiliary contact arrangement is not available on Size 0 and 1 contactors. Size 0 and 1 contactors are design limited to two N.C. auxiliary contacts.

AC Contactors

Type IC5181

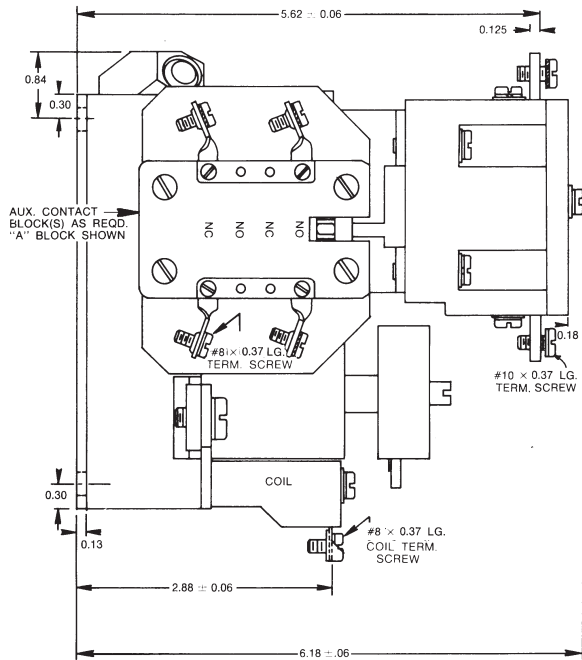

WEIGHT = 10 LBS.

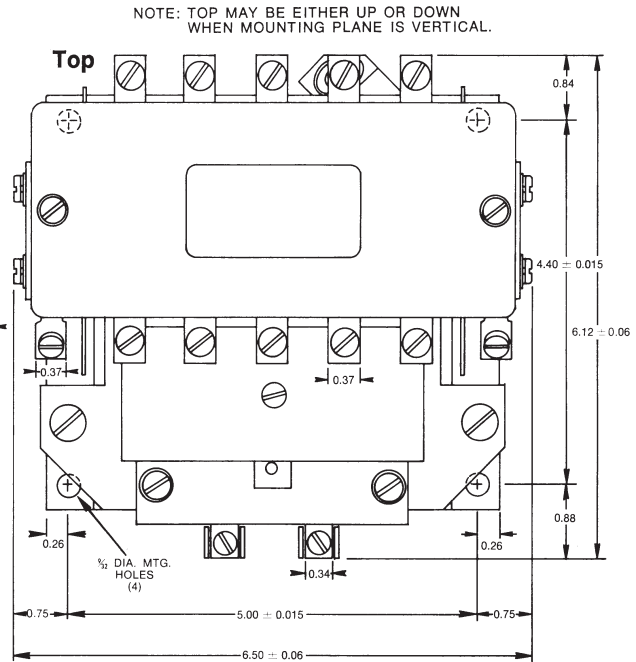

SIZE 2

NOTE: TOP MAY BE EITHER UP OR DOWN WHEN MOUNTING PLANE IS VERTICAL.

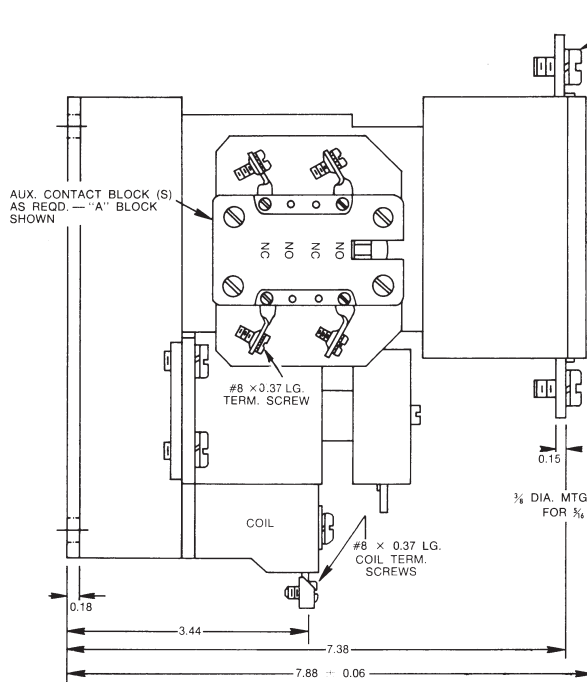

SIZE 3, 4

WEIGHT = 22 LBS.

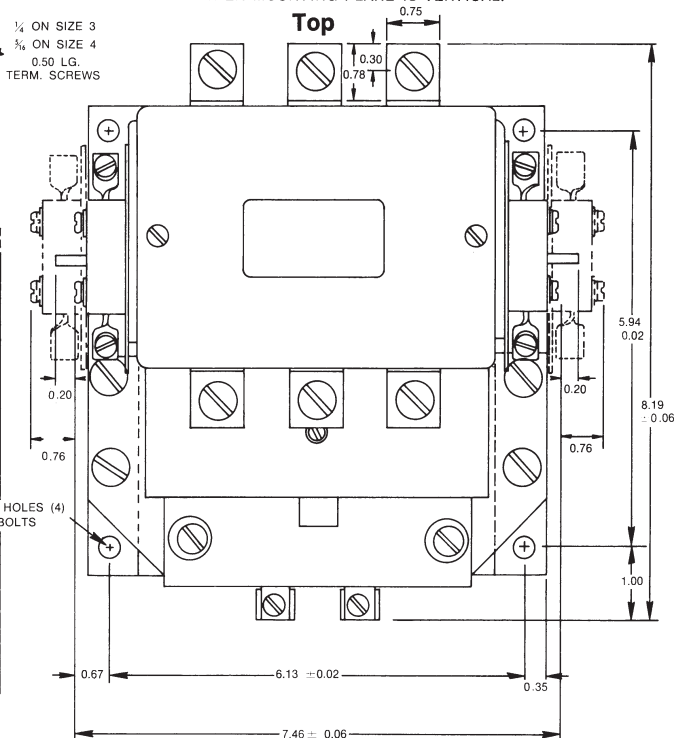

Prices and data subject to change without notice.

AC Contactors

Type IC5181

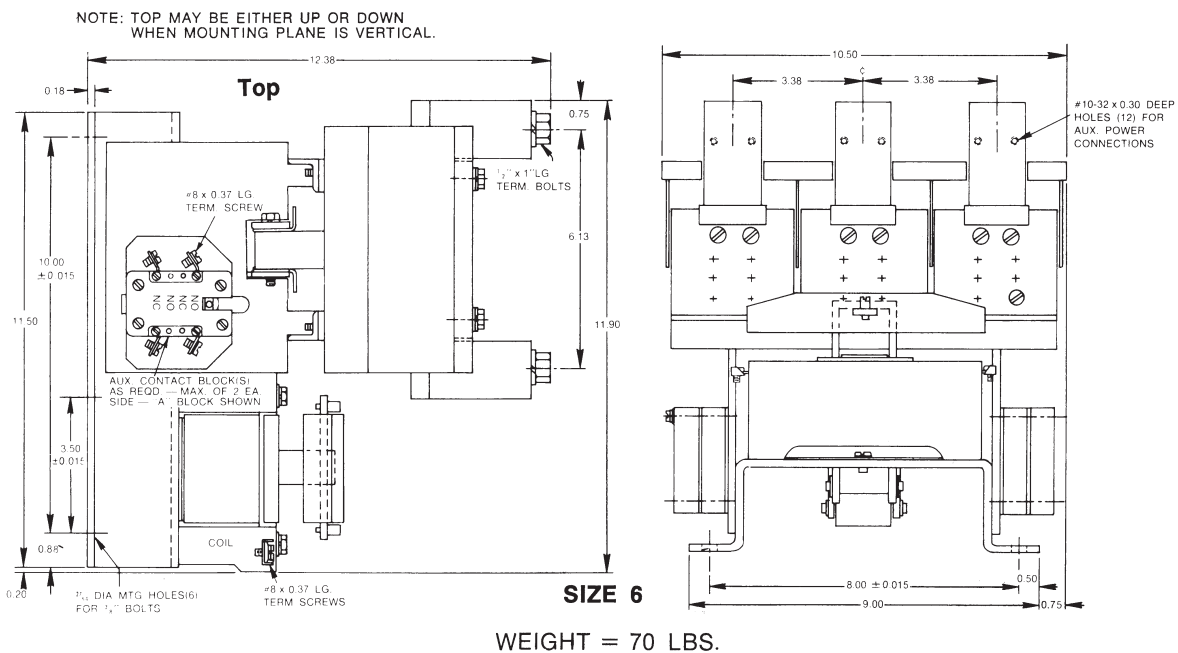
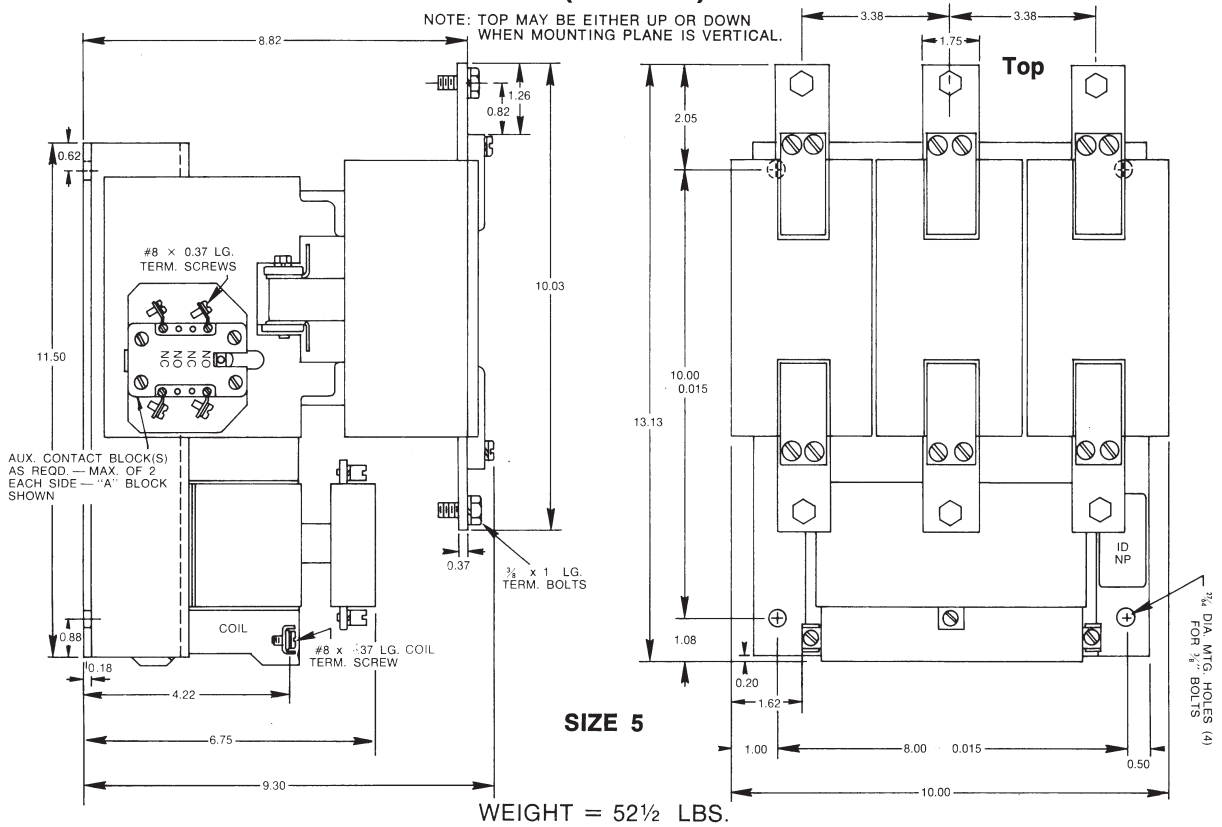

AC Magnetic Contactors

Series 4691

Series 4691 A.C. Magnetic Contactors, both standard and low noise types, are available in Sizes 0-6. Used for motor starting, lamp switching, and heater controls. The 4691 Series meets all applicable military specifications.

Contactors are solenoid operated featuring totally enclosed double break alloy contacts, accessible line, load, and coil terminals and continuous duty operating coils. Contactor parts are compactly arranged on a steel base plate.

Specification	MIL-C-2212 A.C. Control MIL-C-23742 Group Control MIL-C-901 Hi-Shock MIL-STD-167 Vibration MIL-STD-740 Acceptable Noise Criteria (quiet type)
Operation	Magnetic solenoid
Function	Line, accelerating or control contactors.
Type	Series 4691, Types N160 thru N176
Duty	Continuous
Ambient	50° C
Insulation	Class B (coils are Class A)

Auxiliary Contacts

Auxiliary contacts for electrical interlocking, maintaining and other control circuit applications are available in N.O. and N.C. types. Auxiliaries are rated at 5 amps., 440 volts, 60 Hz., (make or break). A maximum of 3 auxiliaries per contactor can be furnished.

Mechanical Interlocks

Mechanically interlocked contactors can be furnished for reversing and multispeed applications.



Size 0



Size 1

AC Magnetic Contactors

Series 4691

Application

Type No.	Size	Motor Horsepower Nonjogging Duty			Elec. Rating Amps. Cont.	Tungsten Lamp Load Amps	Make Amps	Break Amps
		Single Phase		Three Phase				
		115 V	115 V					
N160-1	0	1	2	5	18	10	108	108
N161	1	2	3	10	27	15	162	162
N162	2	3	7 1/2	25	45	30	270	270
N163	3	7 1/2	15	50	90	60	540	540
N164	4	—	25	100	135	120	810	810
N175-1	5	—	—	200	270	180	1620	1620
N176	6	—	—	400	540	—	3240	3240

Repair Parts

Repair parts normally furnished in accordance with applicable part allowance list include:

- 1 set of contacts
- 1 set of springs
- 1 shunt of coil of each size and type

Control Power Requirements

Size	Amperes Holding			Amperes Inrush		
	115 V	220 V	440 V	115 V	220 V	440 V
0, 1, 2	0.29	0.13	0.06	1.9	0.91	0.38
3, 4	1.2	.51	.27	12.3	5.6	2.8
5, 6	1.4	—	.32	4.3	—	0.94

Notes: The 356L1 coil and a 15 watt (actual load) 833 ohm resistor are connected in series across the output of a full wave bridge rectifier for 115 volts 60 hertz service voltage.

The 356L2 coil and a 58 watt (actual load) 3.2K ohm resistor are connected in series across the output of a full wave bridge rectifier for 440 volt 60 hertz service voltage.

Ordering Information

When ordering Series 4691 A.C. Contactors, specify:

1. Type No. or Contactor size
2. Coil voltage and frequency
3. No. of auxiliary contactors (N.O. or N.C.)
4. Open or enclosed
5. Repair parts (if required)
6. Special environmental requirements
7. Application

Dimensions in Inches (approx.)

Contactor Size	A	B Auxiliaries			C	D Aux. 1 or 2	E	F Dia.	G	H	I	J	K	Weight in Lbs. Approx.
		1	2	3										
0, 1, 2	6 1/8	7 1/16	7 1/16	8 1/16	5 1/16	—	3 9/16	(4) 17/64	5/16	4 1/4	5/16	5/16	5 1/2	5
3, 4	10 15/16	—	—	—	8 11/16	31/32	6 5/16	(4) 13/32	11/16	7 1/8	11/16	11/16	9 9/16	21
5, 6	16 3/4	—	—	—	16 3/4	—	15 3/8	(4) 9/16	7/8	14 1/2	7/8	13/16	15 1/8	85

Dimensions

